









 Ø6,3x50 mm <b>A1 x 70</b>	 Ø12 mm <b>A2 x 70</b>	 4 mm <b>A3 x 1</b>	 Ø15x12 mm <b>B1 x 22</b>	 Ø5x44 mm <b>B2 x 22</b>
 Ø20 mm <b>B3 x 22</b>	 Ø4x16 mm <b>D1 x 96</b>	 Ø3x25 mm <b>D2 x 7</b>	 Ø1,6x25 mm <b>F x 251</b>	 Ø8x36 mm <b>G x 67</b>
 <b>K x 8</b>	 <b>N x 5</b>	 845 mm <b>O1 x 2</b>	 <b>Z x 7</b>	

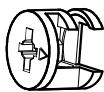
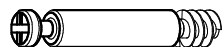

### Box 1/3

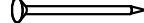
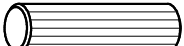
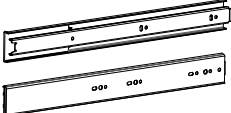
847x424x16 mm

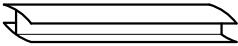

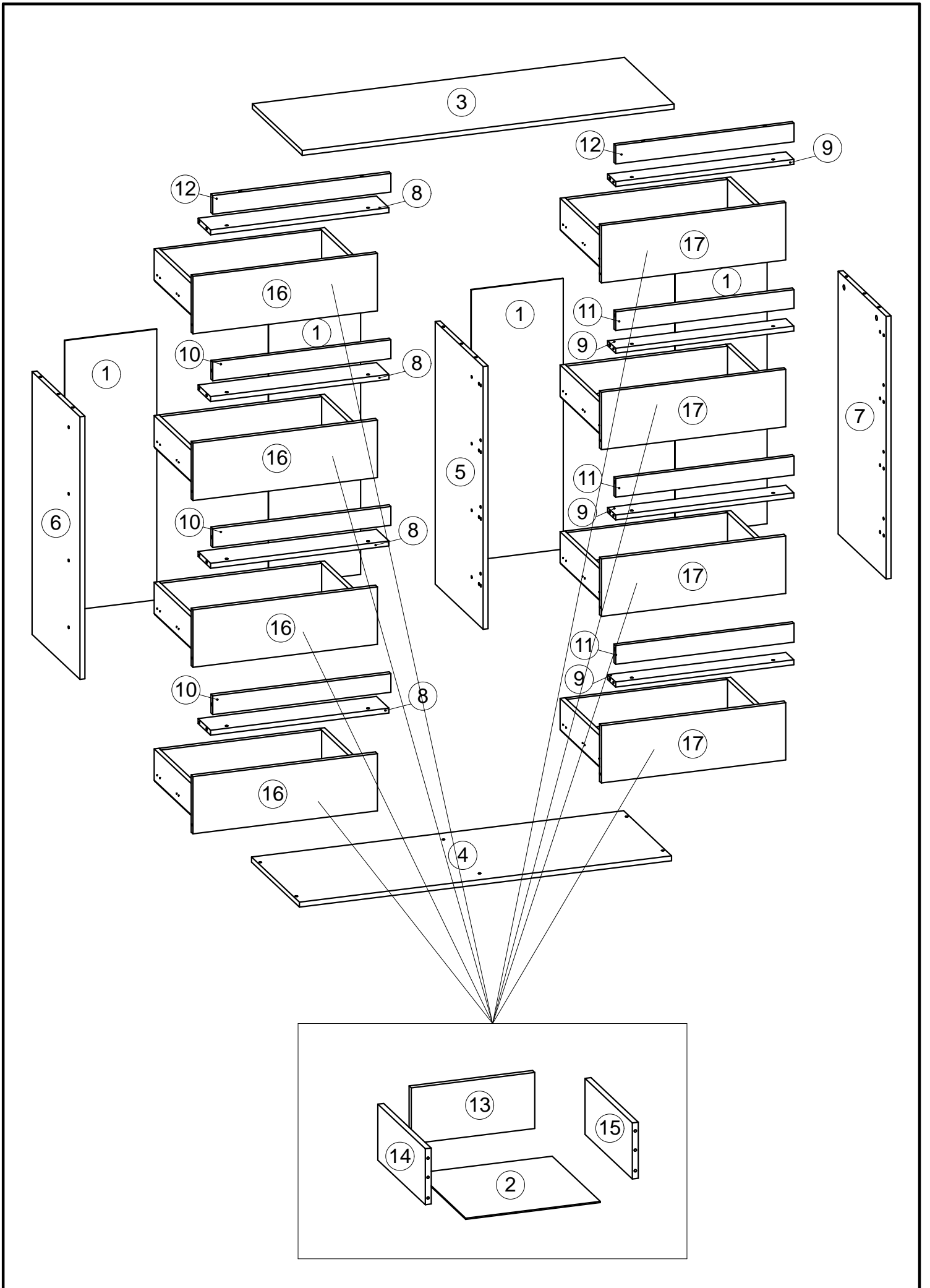
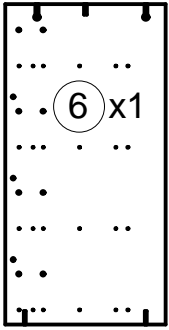
847x424x16 mm

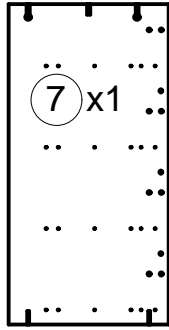

594x184x16 mm

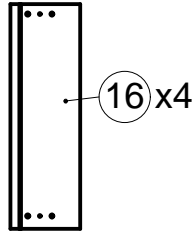

594x184x16 mm

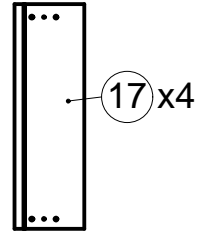

Fittings & Tools

### Box 2/3

847x424x16 mm

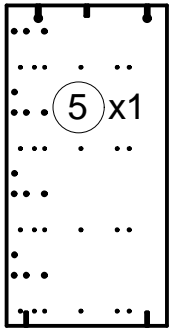

575x110x16 mm

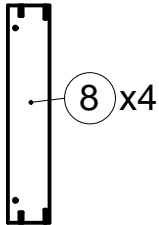

575x70x16 mm

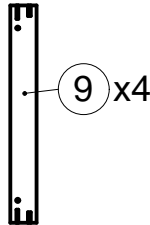

575x60x16 mm

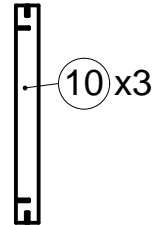

575x60x16 mm

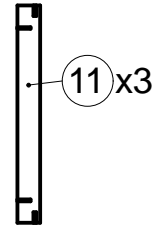

400x100x16 mm

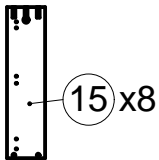

518x100x16 mm

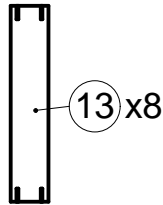

400x100x16 mm

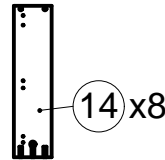

575x60x16 mm

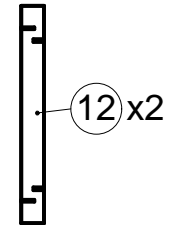

### Box 3/3

873x297x3 mm

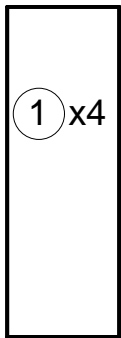

548x406x3 mm

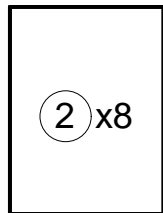

1199x440x16 mm

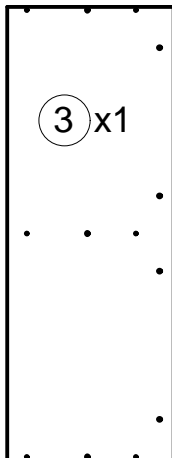

1199x424x16 mm

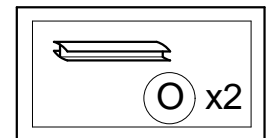
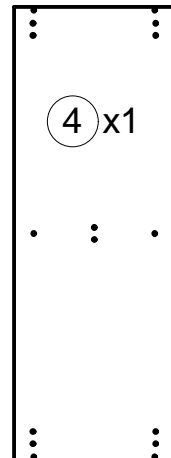

1

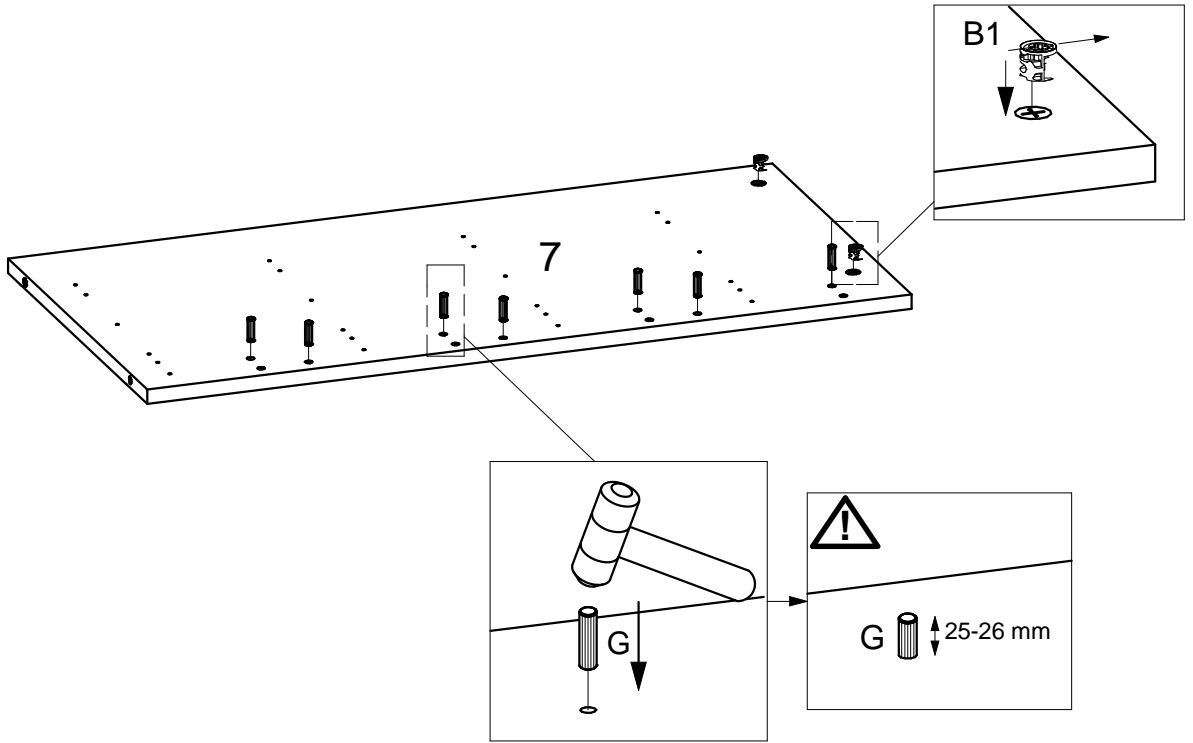
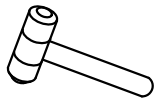
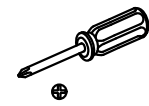
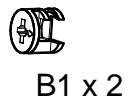
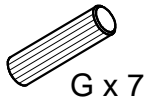

2

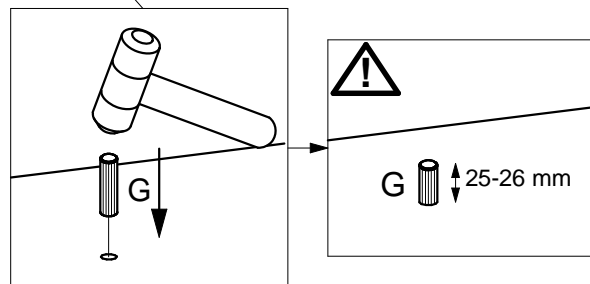
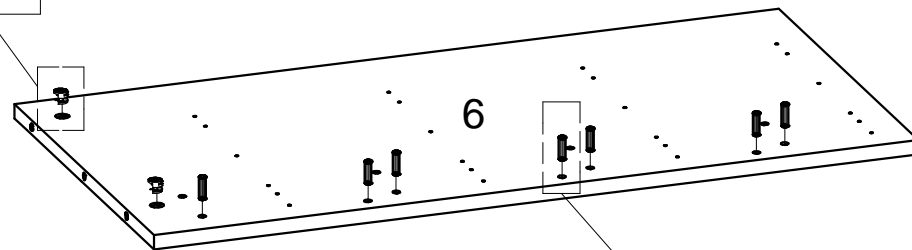
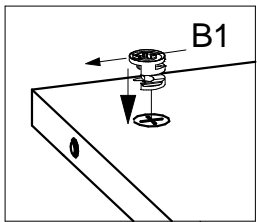
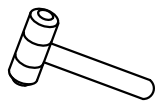
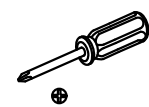
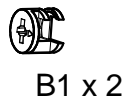
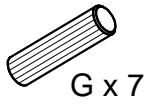

3

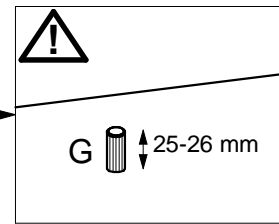
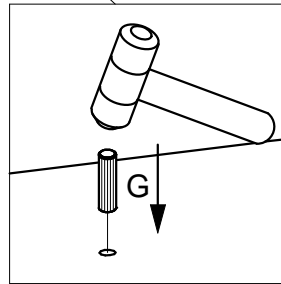
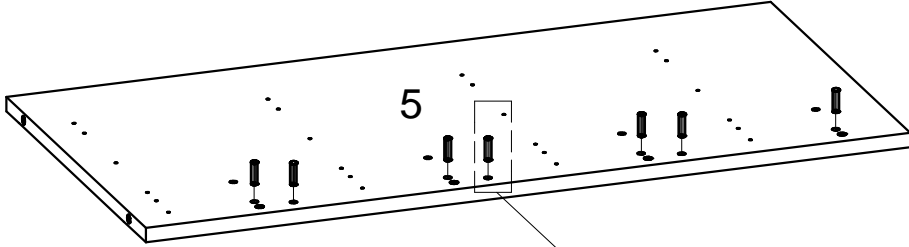
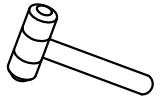
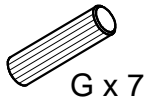

4

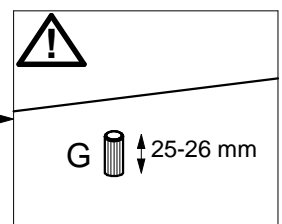
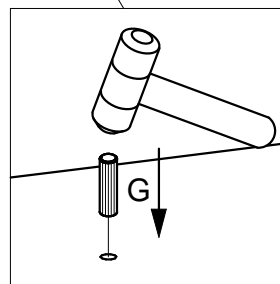
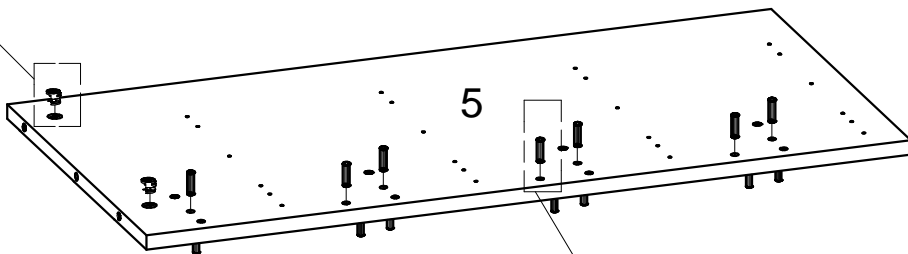
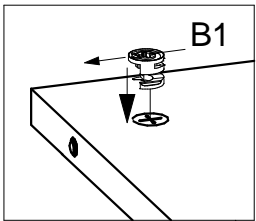
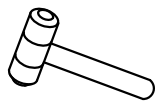
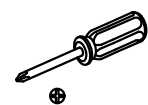
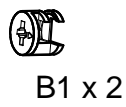
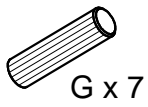

5

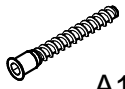

A1 x 4



A2 x 4



A3 x 1

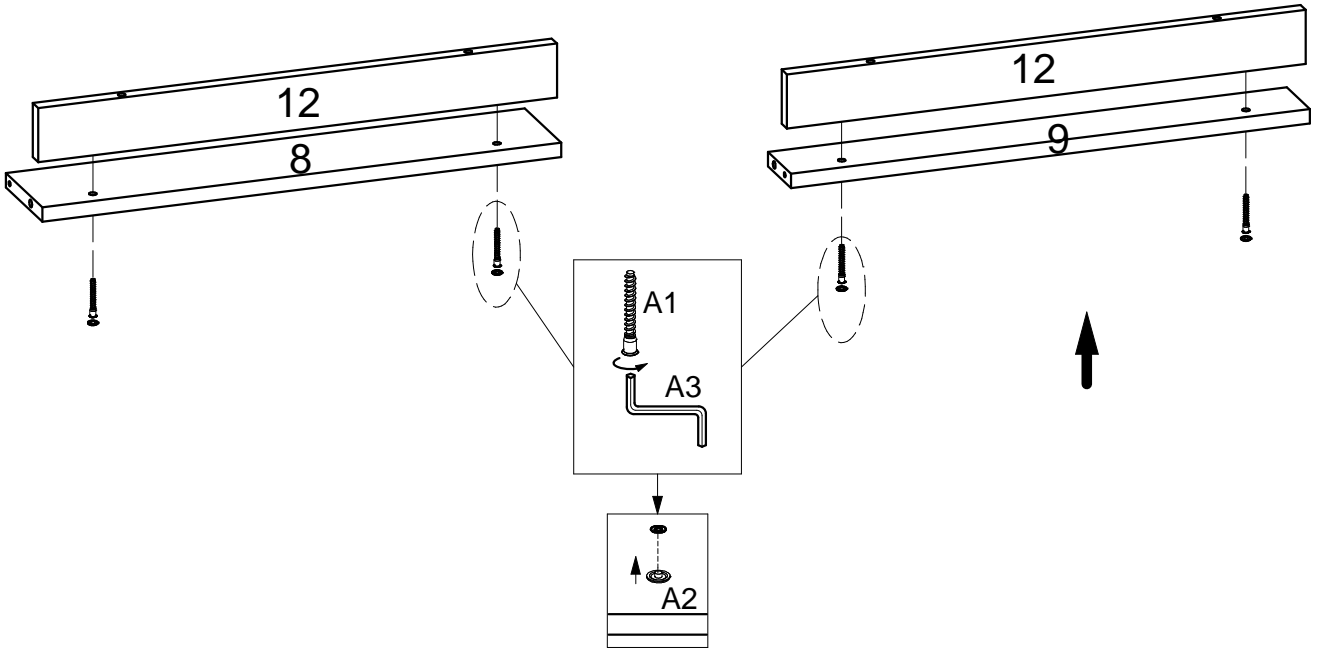

6

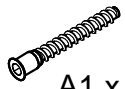

A1 x 6



A2 x 6



A3 x 1

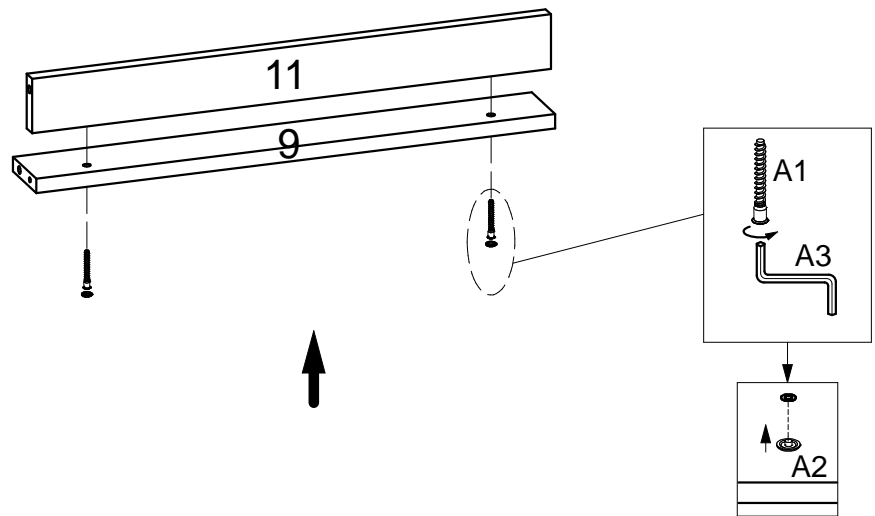

x 3



7

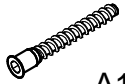

A1 x 6



A2 x 6



A3 x 1

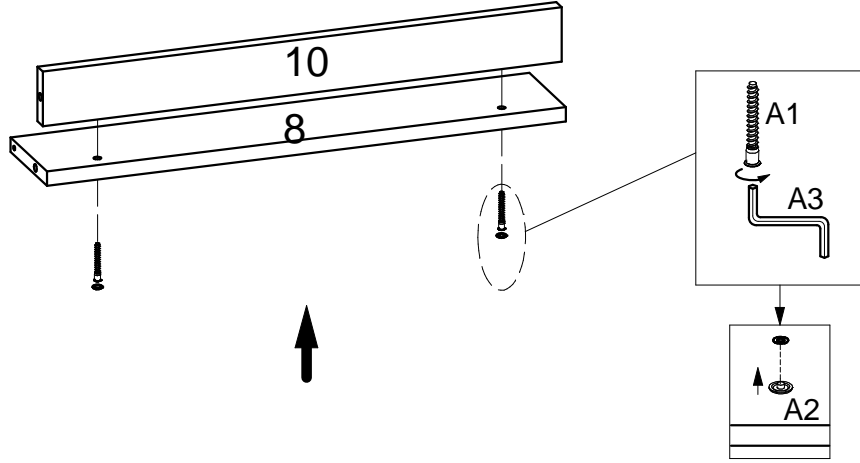

x 3

8

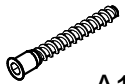

A1 x 8



A2 x 8



A3 x 1

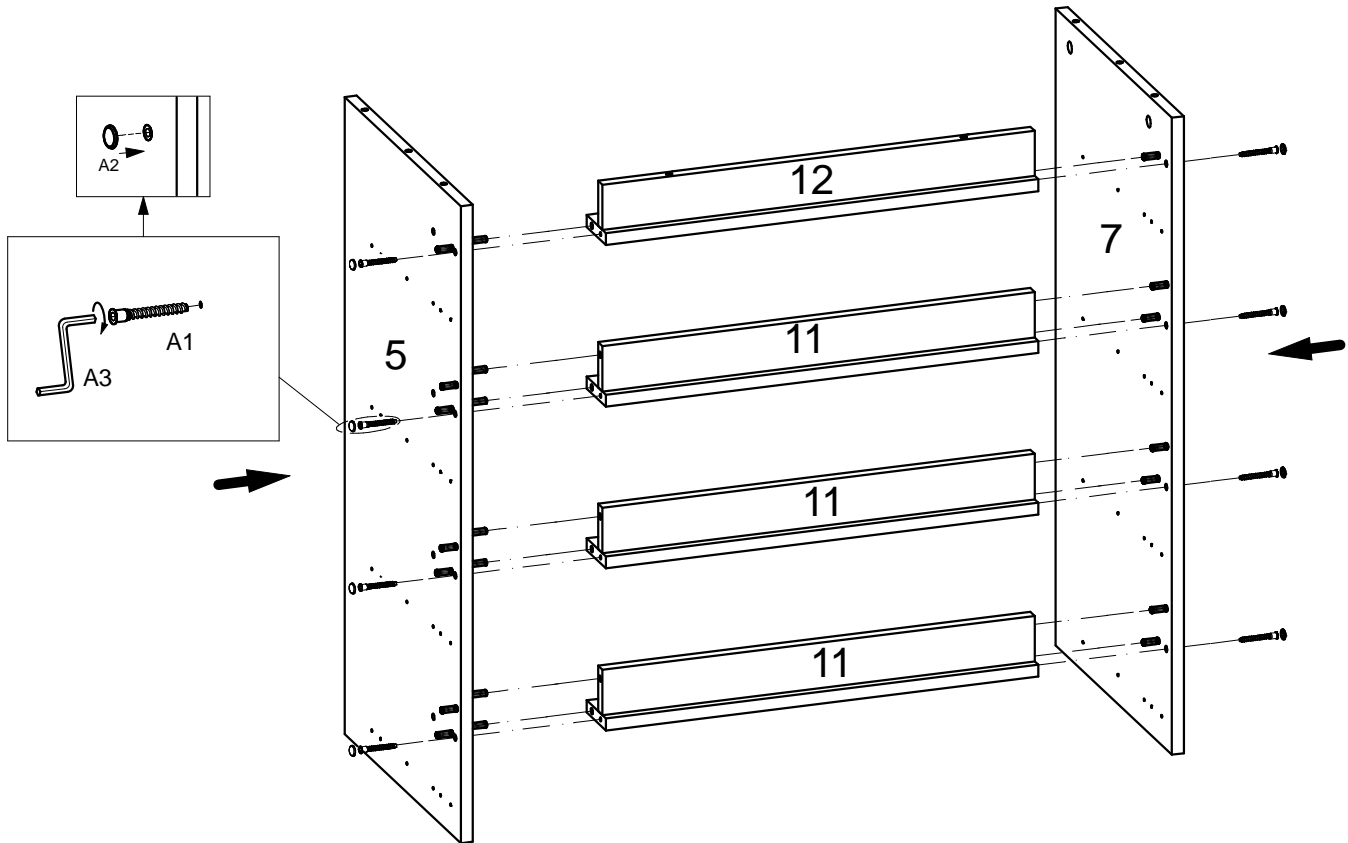
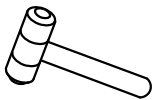

9

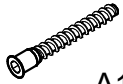

A1 x 8



A2 x 8



A3 x 1

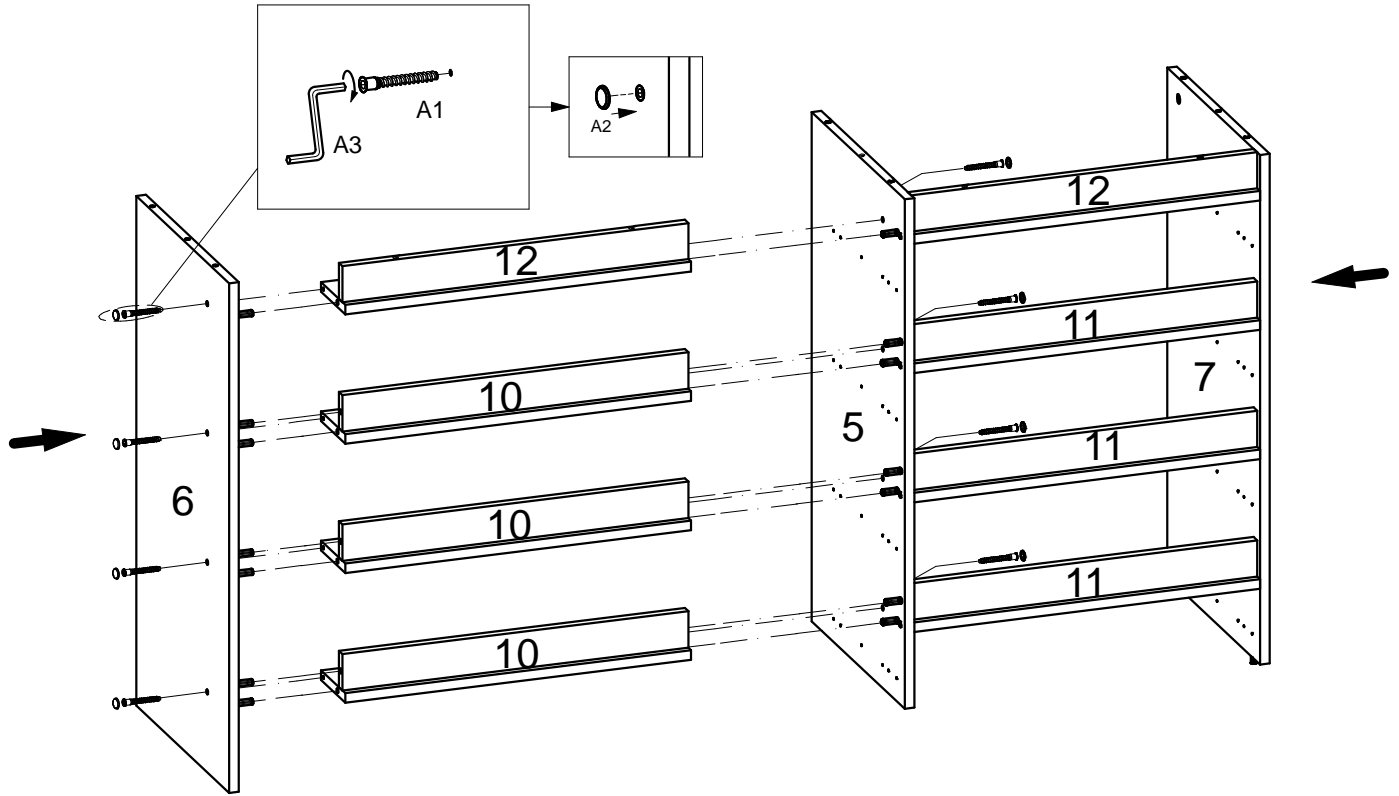
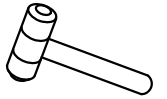

10



B2 x 6



G x 7

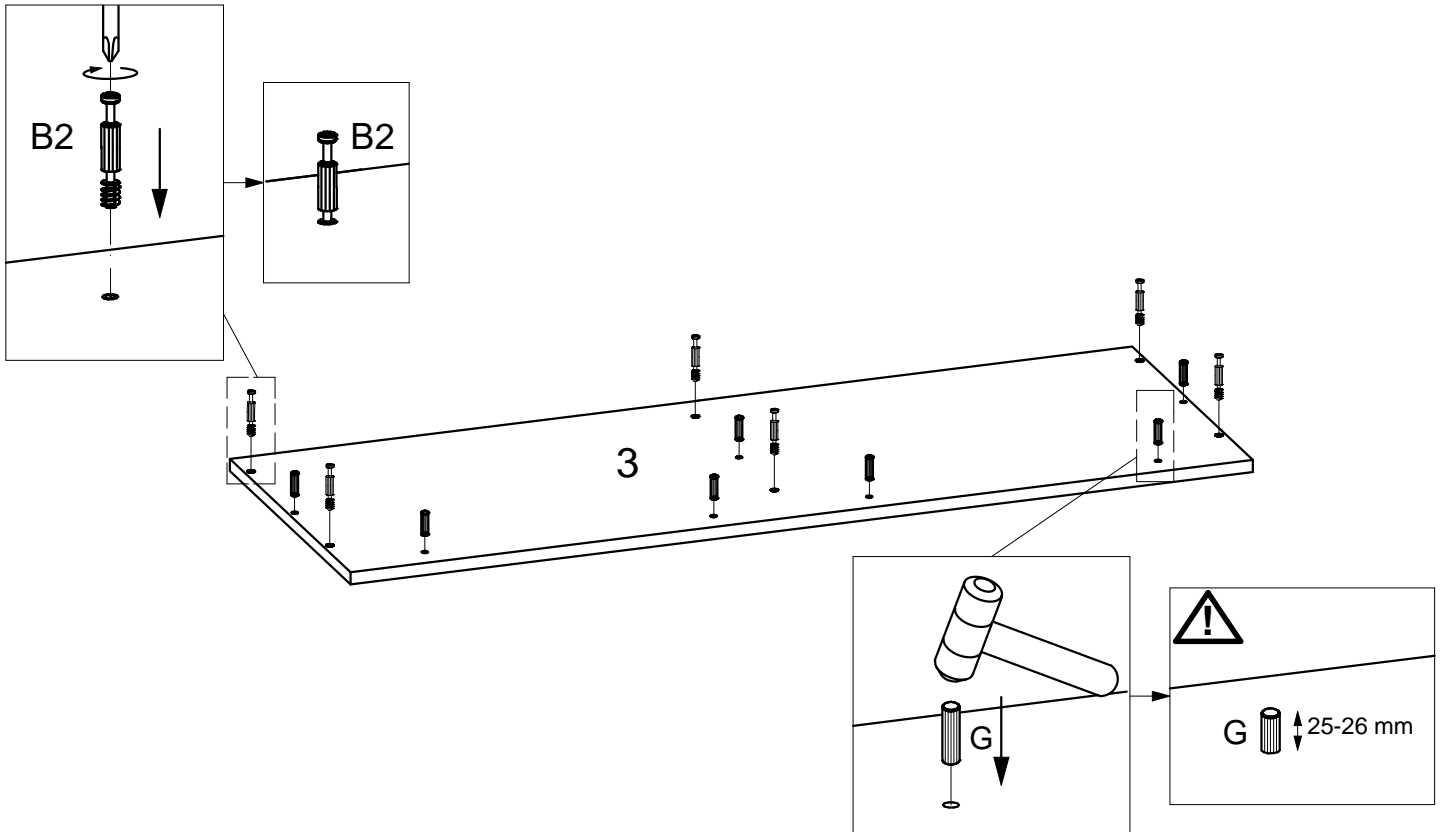
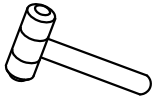
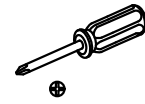

11

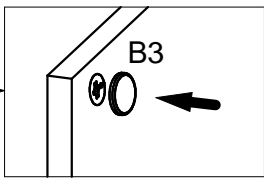
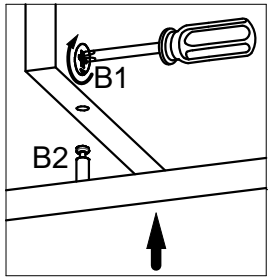
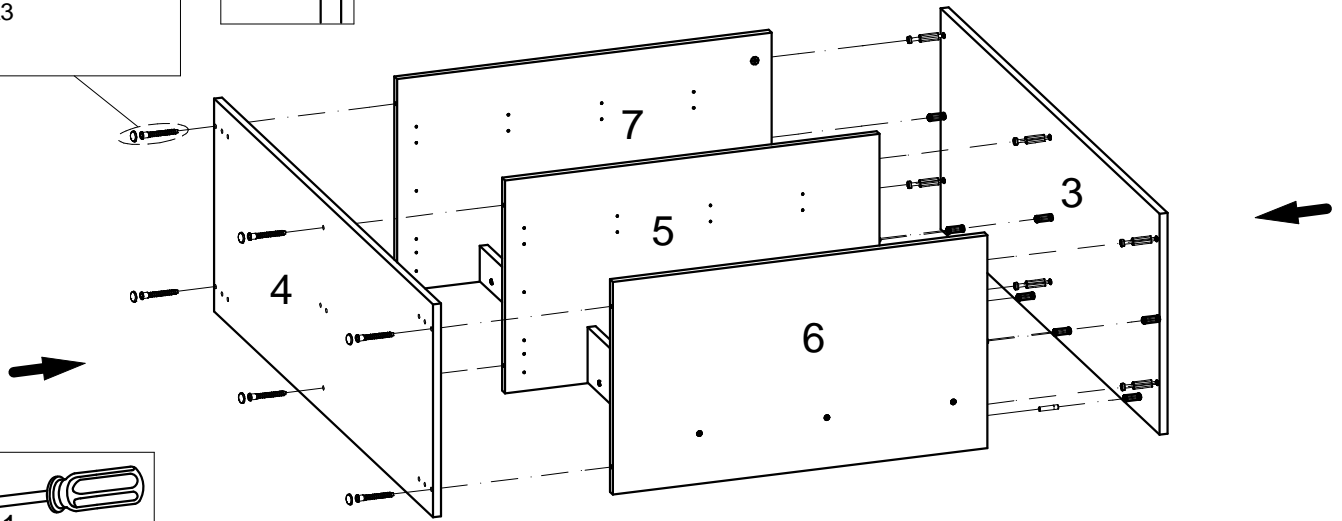
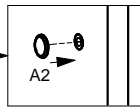
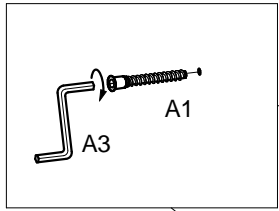
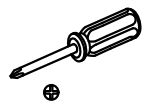
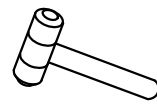
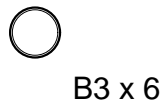
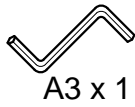
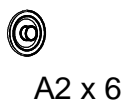
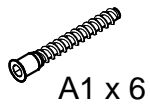

12

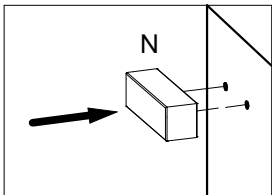
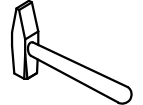
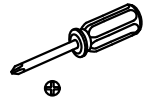
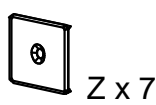
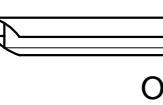
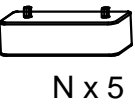
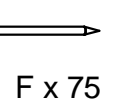

⚠ XX=YY≅90°

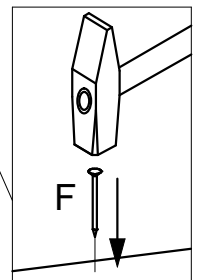
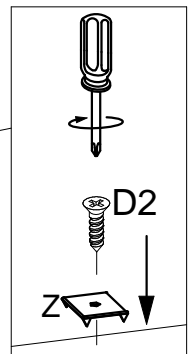
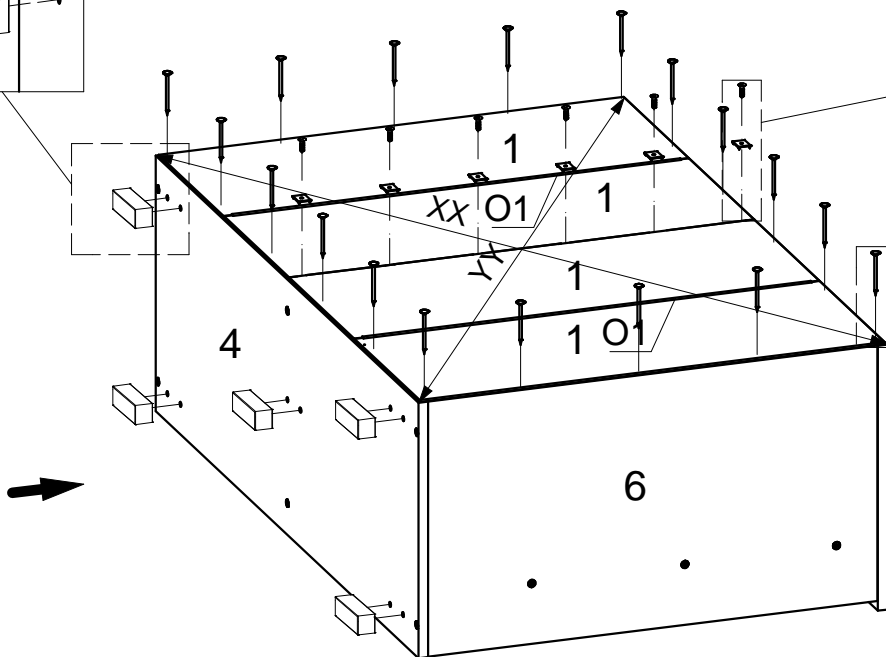

13



D1 x 48



K.1 x 8



K.2 x 8

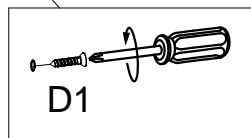
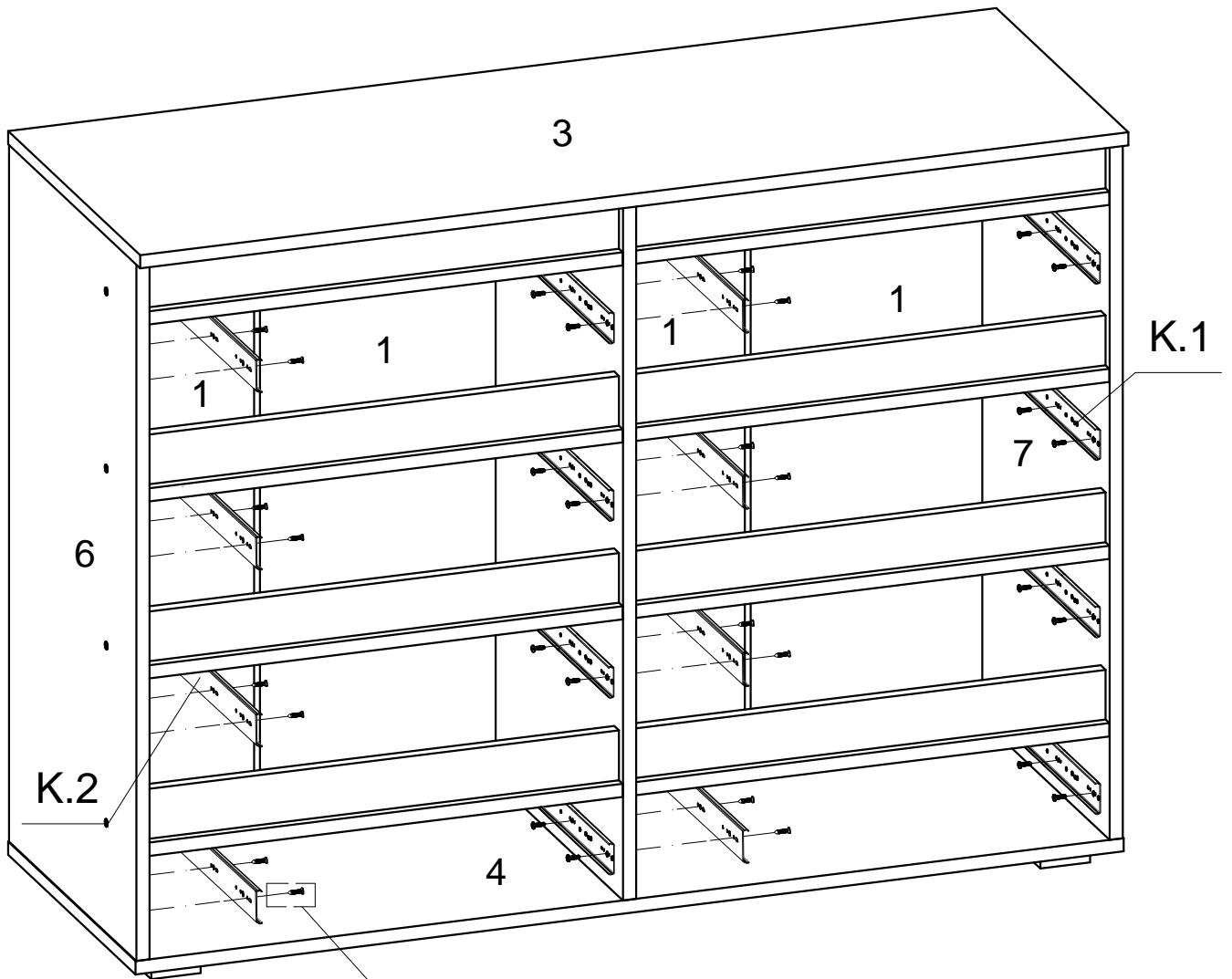
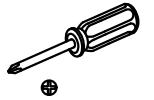

14

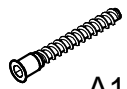

A1 x 32



A2 x 32



A3 x 1



B1 x 16

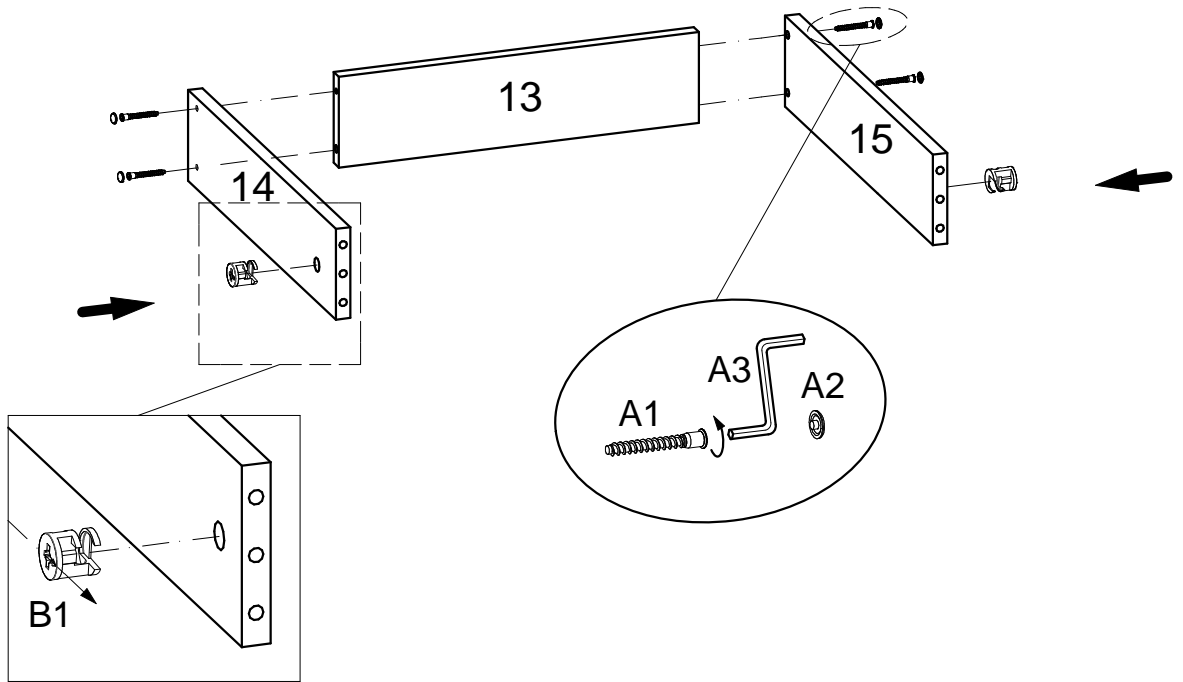

x 8

15



B2 x 8



B3 x 8



G x 16

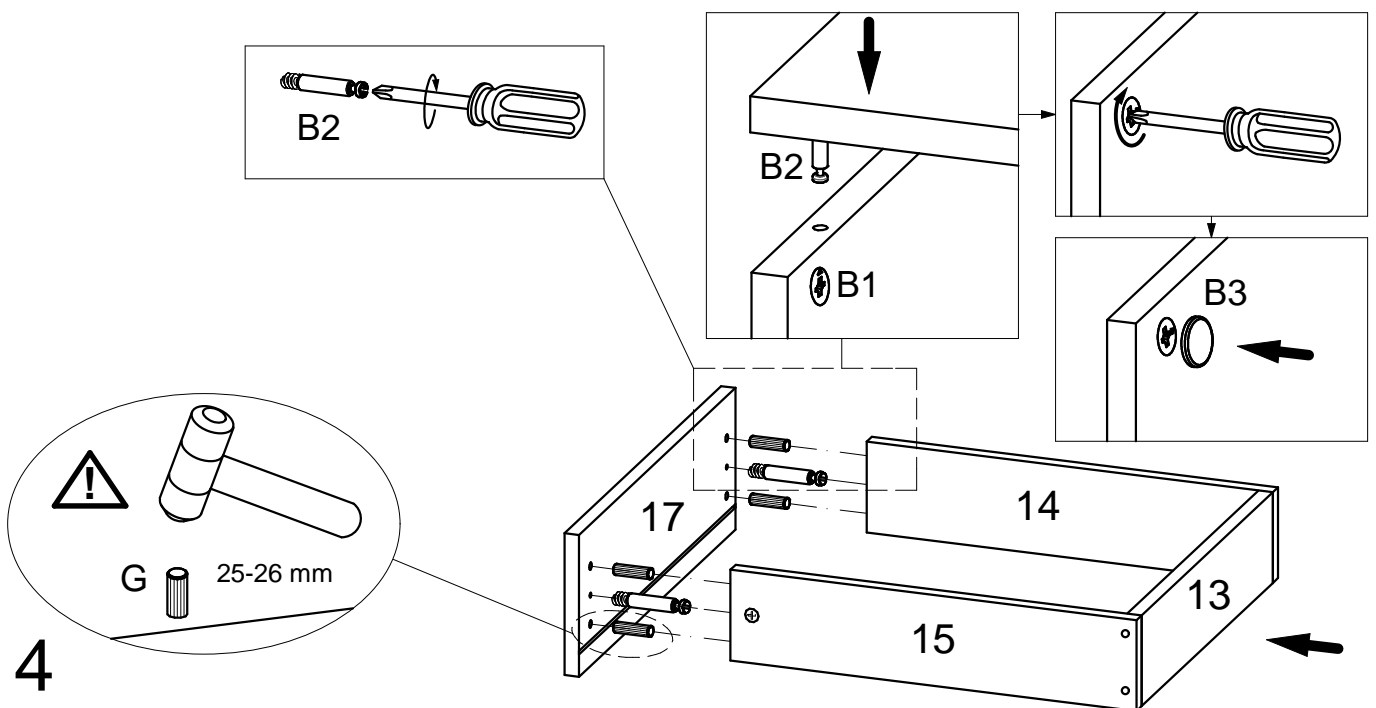
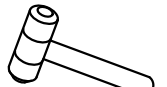
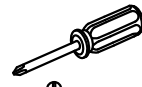

x 4

16

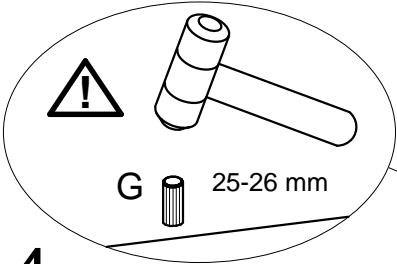
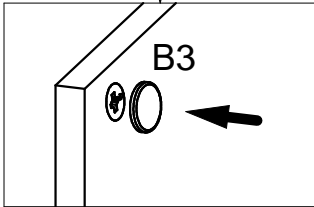
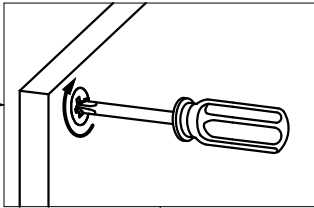
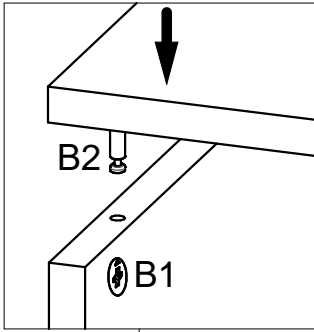
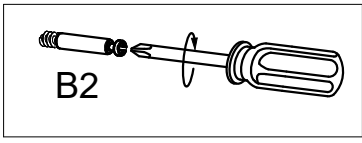

x 4

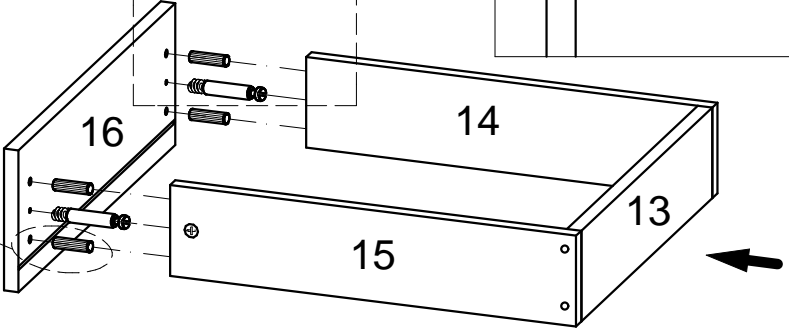

17



!  $XX=YY \cong 90^\circ$

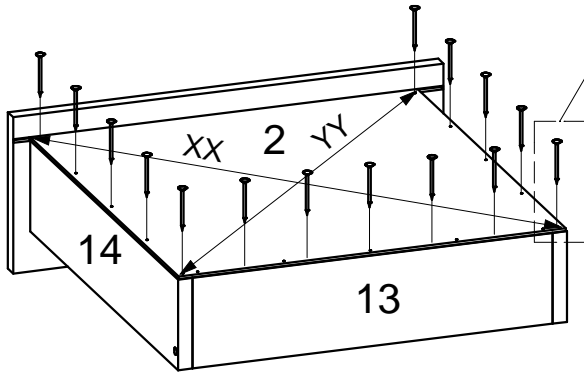
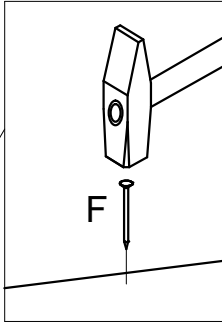

x 8

18



D1 x 24



K.3 x 4



K.4 x 4

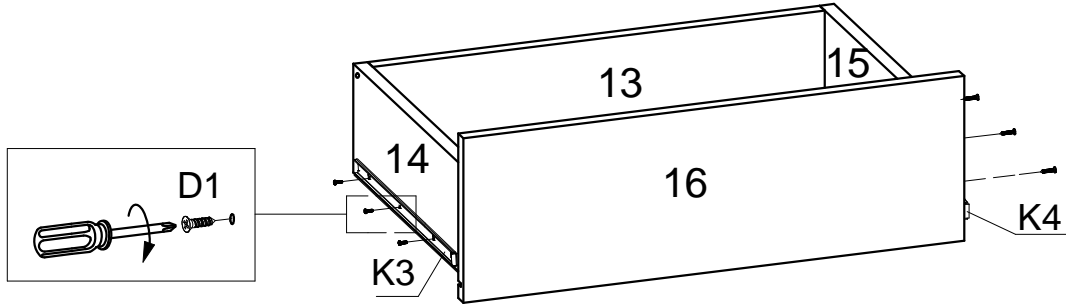
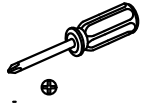

x 4

19



D1 x 24

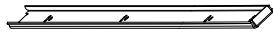

K.3 x 4



K.4 x 4

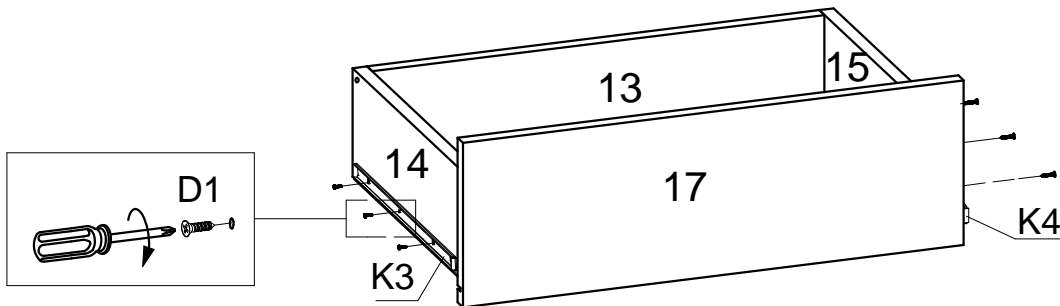
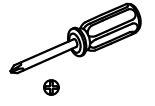

x 4

20

